



US011406894B2

(12) **United States Patent**  
**Paradise et al.**

(10) **Patent No.:** **US 11,406,894 B2**  
(45) **Date of Patent:** **Aug. 9, 2022**

(54) **ONLINE SOFTWARE VIDEO CAPTURE AND REPLAY SYSTEM**

*13/355* (2014.09); *A63F 13/49* (2014.09);  
*A63F 2300/634* (2013.01)

(71) Applicant: **Skillz Platform Inc.**, San Francisco, CA (US)

(58) **Field of Classification Search**

CPC ..... *A63F 13/497*; *A63F 13/49*; *A63F 13/352*;  
*A63F 13/355*; *A63F 13/30*; *A63F 13/12*;  
*A63F 2300/634*

(72) Inventors: **Andrew Paradise**, San Francisco, CA (US); **James Daniels**, Boston, MA (US); **Jason Petralia**, Winchester, MA (US)

USPC ..... 463/31  
See application file for complete search history.

(73) Assignee: **Skillz Platform Inc.**, San Francisco, CA (US)

(56) **References Cited**

U.S. PATENT DOCUMENTS

(\*) Notice: Subject to any disclaimer, the term of this patent is extended or adjusted under 35 U.S.C. 154(b) by 144 days.

6,699,127 B1 3/2004 Lobb et al.  
8,255,815 B2 \* 8/2012 Ordning ..... G06F 16/54  
715/764

(21) Appl. No.: **16/428,444**

9,630,097 B2 4/2017 Paradise et al.  
2008/0161113 A1 7/2008 Hansen et al.

(22) Filed: **May 31, 2019**

(Continued)

(65) **Prior Publication Data**

US 2019/0282901 A1 Sep. 19, 2019

*Primary Examiner* — Michael A Cuff

(74) *Attorney, Agent, or Firm* — Mintz Levin Cohn Ferris and Popeo, P.C.

**Related U.S. Application Data**

(63) Continuation of application No. 15/494,776, filed on Apr. 24, 2017, now Pat. No. 10,307,647, which is a continuation of application No. 14/224,889, filed on Mar. 25, 2014, now Pat. No. 9,630,097.

(60) Provisional application No. 61/930,406, filed on Jan. 22, 2014.

(51) **Int. Cl.**

*A63F 13/497* (2014.01)  
*A63F 13/30* (2014.01)  
*A63F 13/49* (2014.01)  
*A63F 13/352* (2014.01)  
*A63F 13/355* (2014.01)

(57) **ABSTRACT**

A user-activity video signal can be received. The user-activity video signal can comprise a video capture characterizing a user's interaction with a software application on a client. The software application can have an interface display space on the client and the software application can execute on the client in operation with at least one remote backend computing system. Backend user interaction data corresponding to the user's interaction with the software application as generated by the at least one remote backend computing system can be received. A new video comprising a plurality of divided segments of the user-activity video signal can be generated automatically using the backend user interaction data and a plurality of predefined rules. The new video can be provided. Related apparatus, systems, techniques, and articles are also described.

(52) **U.S. Cl.**

CPC ..... *A63F 13/497* (2014.09); *A63F 13/30* (2014.09); *A63F 13/352* (2014.09); *A63F*

**19 Claims, 6 Drawing Sheets**

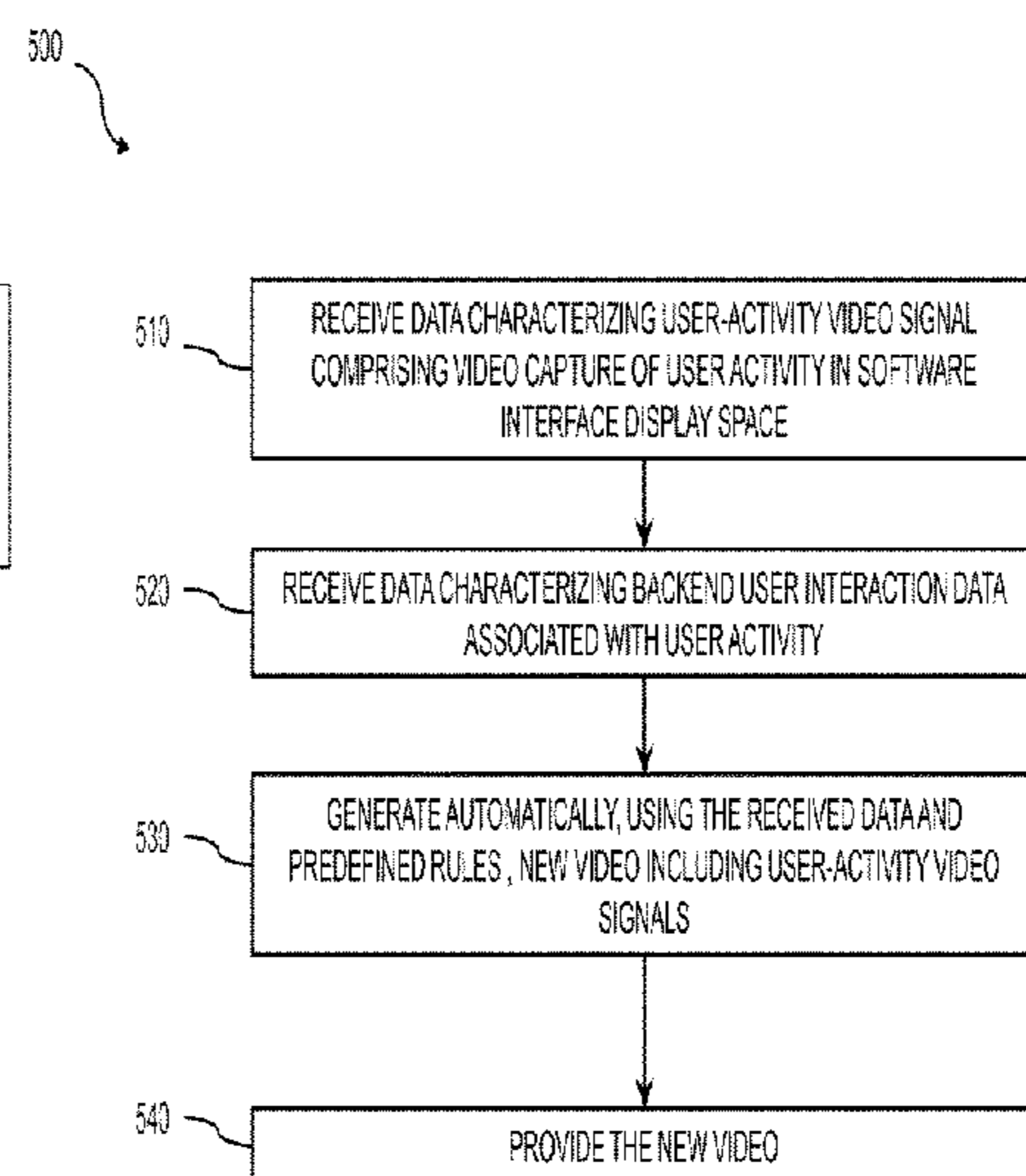
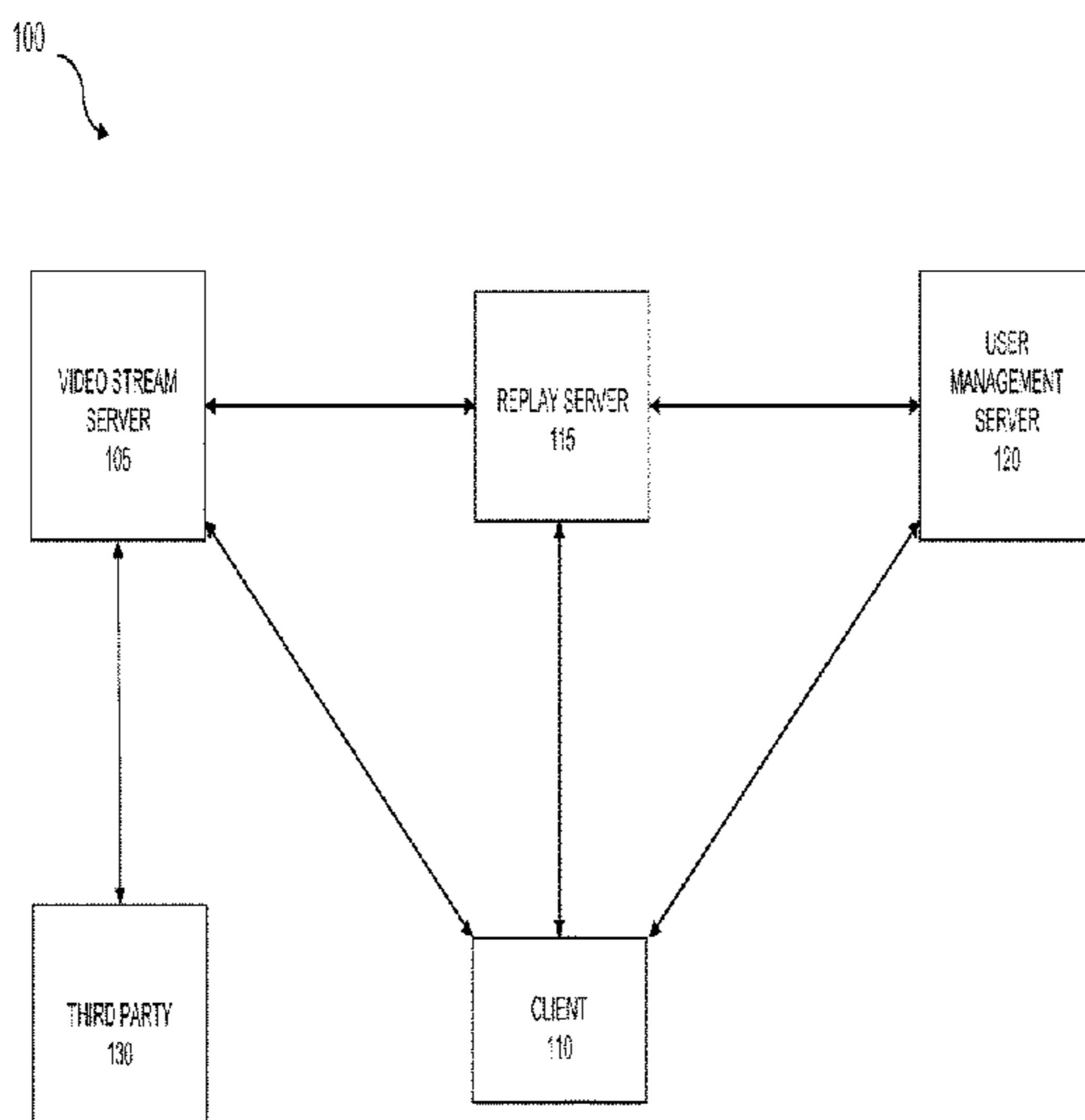

(56)

References Cited

U.S. PATENT DOCUMENTS

2009/0125968	A1 *	5/2009	Perlman .....	H04N 21/435 725/133	2012/0281080	A1	11/2012	Wang	
2009/0131177	A1	5/2009	Pearce		2013/0084959	A1 *	4/2013	Nelson .....	G07F 17/3244 463/25
2009/0149259	A1 *	6/2009	Van Luchene .....	A63F 9/183 463/42	2013/0121614	A1	5/2013	Intwala	
2009/0208181	A1	8/2009	Cottrell		2013/0151614	A1	6/2013	Beerse et al.	
2010/0172624	A1 *	7/2010	Watts .....	H04N 5/77 386/278	2013/0172086	A1	7/2013	Ikenaga	
2010/0223649	A1 *	9/2010	Suitts .....	H04N 21/8549 725/105	2013/0226983	A1	8/2013	Beining et al.	
2010/0241699	A1	9/2010	Muthukumarasamy et al.		2013/0339473	A1	12/2013	McCaffrey et al.	
2010/0304860	A1	12/2010	Gault et al.		2013/0344960	A1	12/2013	Perry et al.	
2011/0010386	A1	1/2011	Zeinfeld		2014/0194173	A1 *	7/2014	Nicholas .....	A63F 13/31 463/9
2011/0072056	A1	3/2011	Bakalash et al.		2015/0024839	A1 *	1/2015	Zahn .....	H04N 21/2343 463/31
2012/0013622	A1	1/2012	Mahajan et al.		2015/0035757	A1 *	2/2015	Mahlmeister .....	G06F 3/016 345/173
2012/0156668	A1	6/2012	Zelin		2015/0141140	A1 *	5/2015	Lampe .....	H04N 21/8549 463/31
2012/0189273	A1 *	7/2012	Folgnier .....	H04N 21/2187 386/241	2015/0202529	A1	7/2015	Paradise et al.	

\* cited by examiner

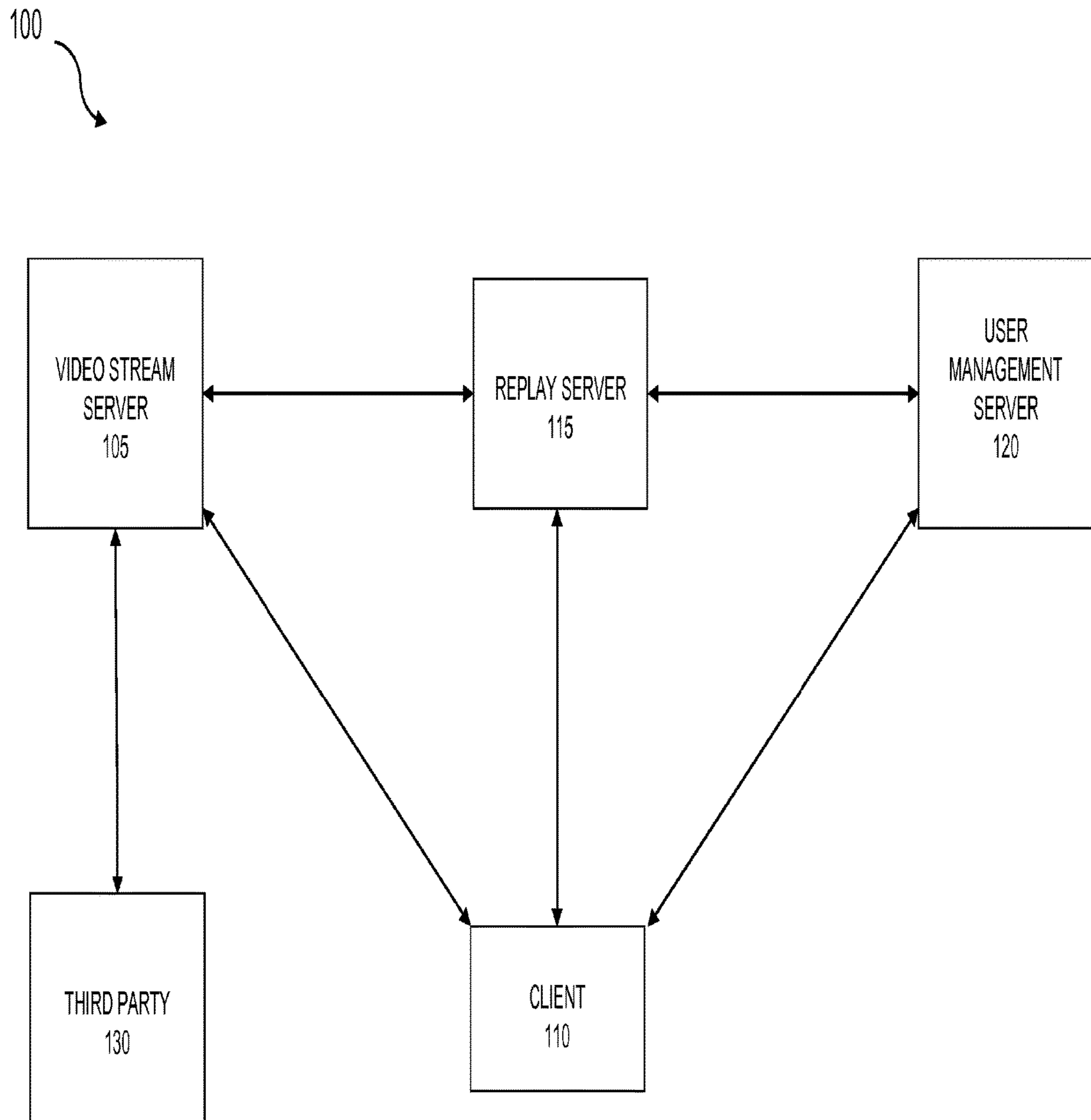
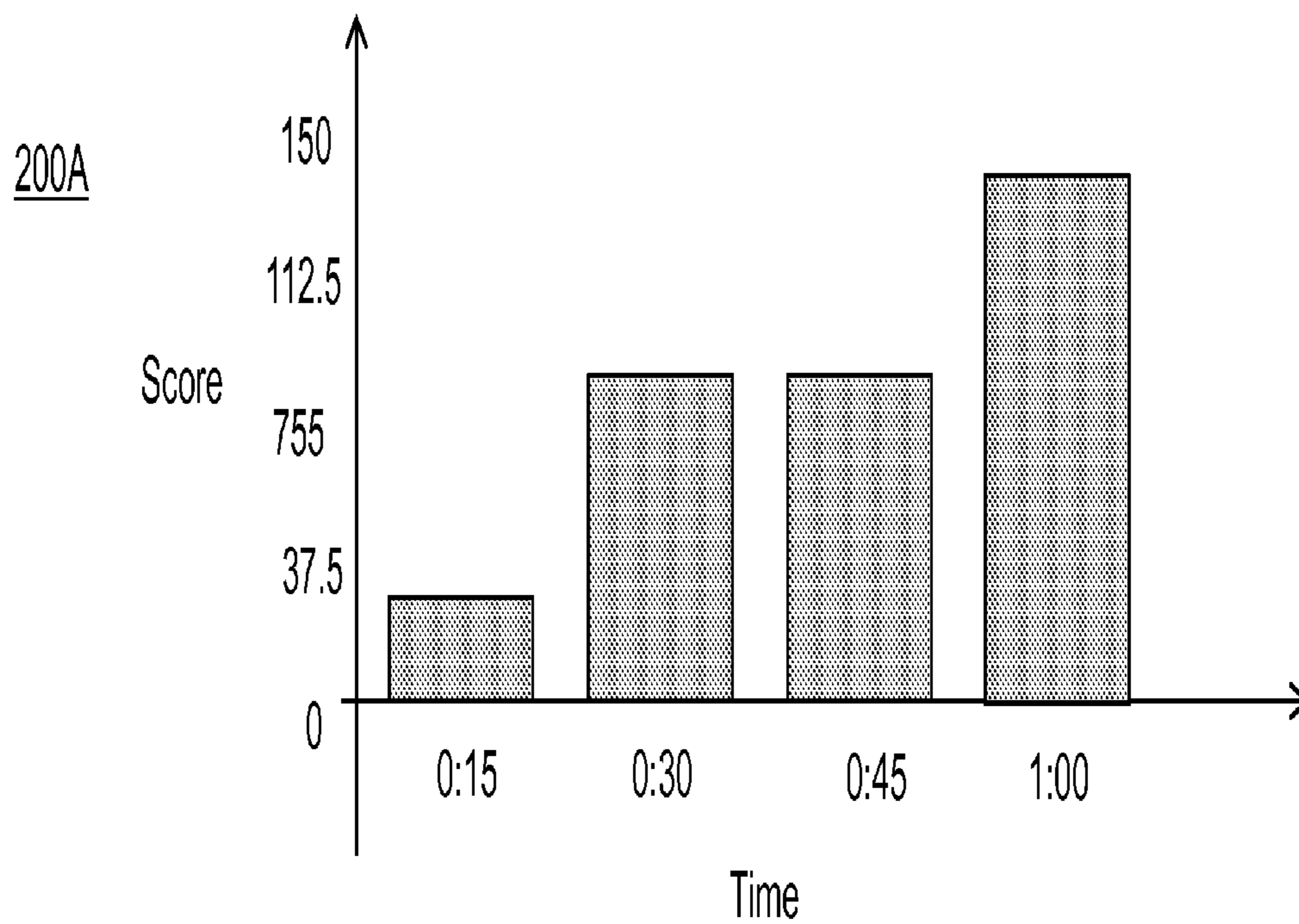
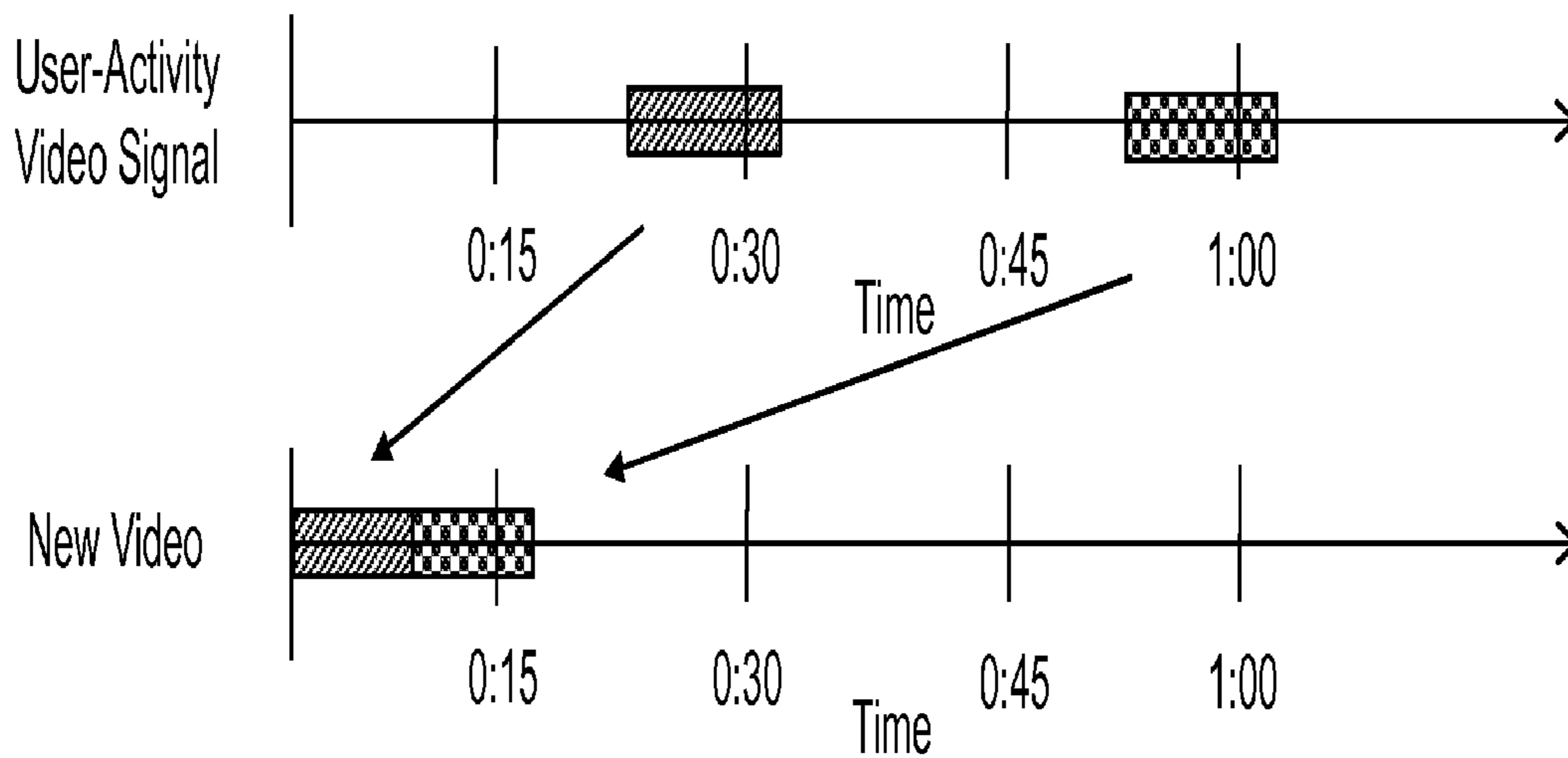

FIG. 1



**FIG. 2A**

200B



**FIG. 2B**

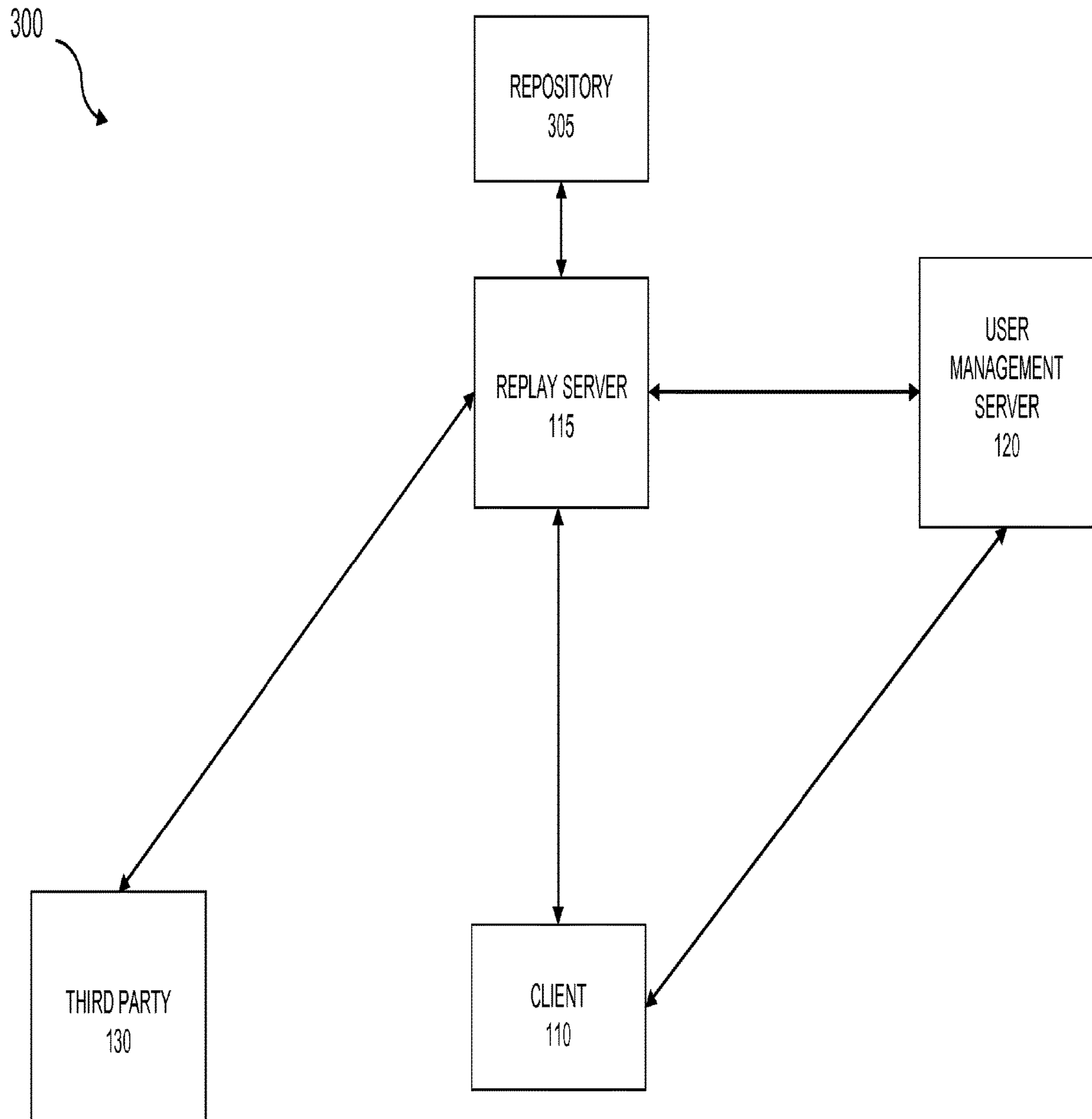

FIG. 3

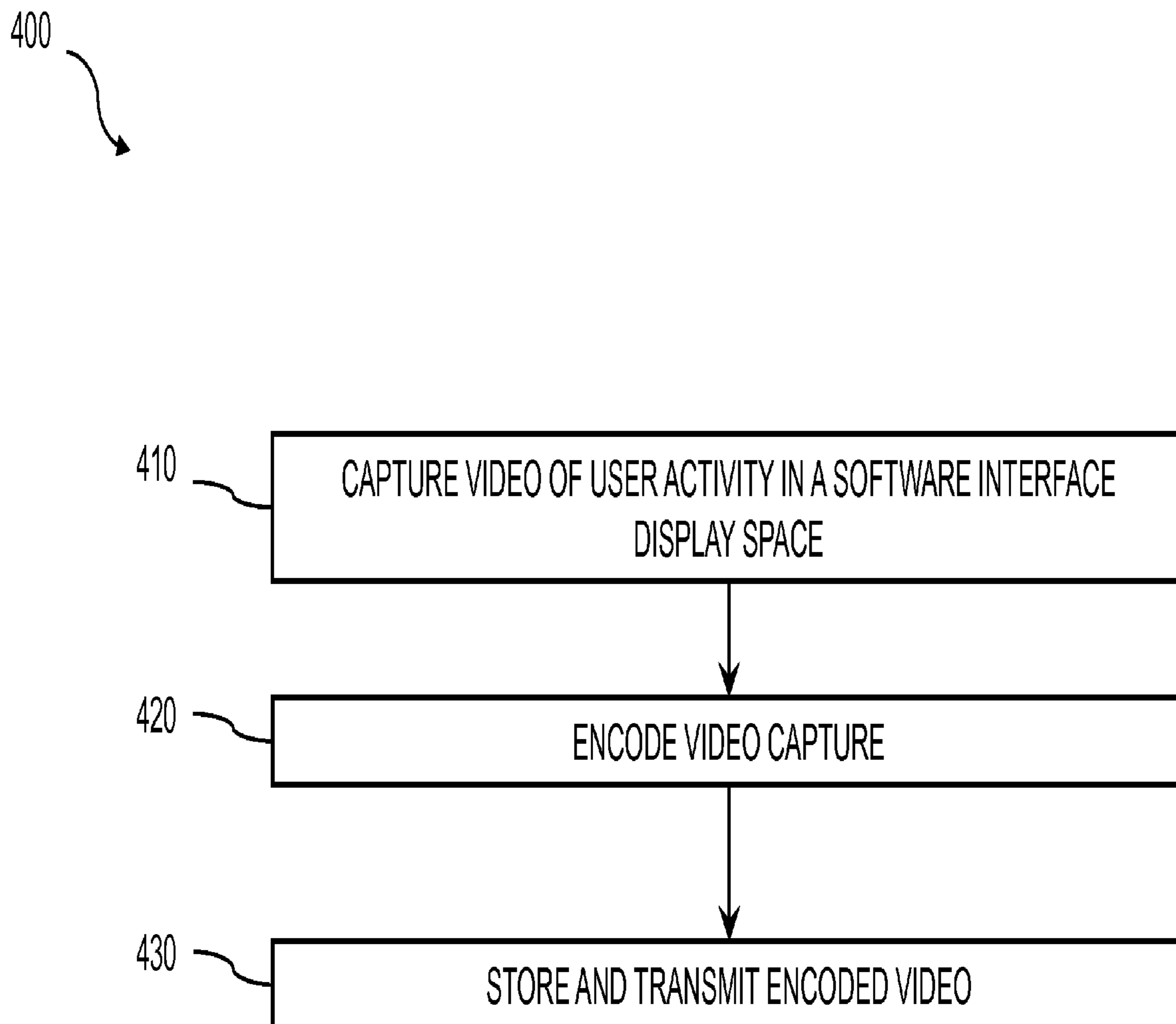

FIG. 4

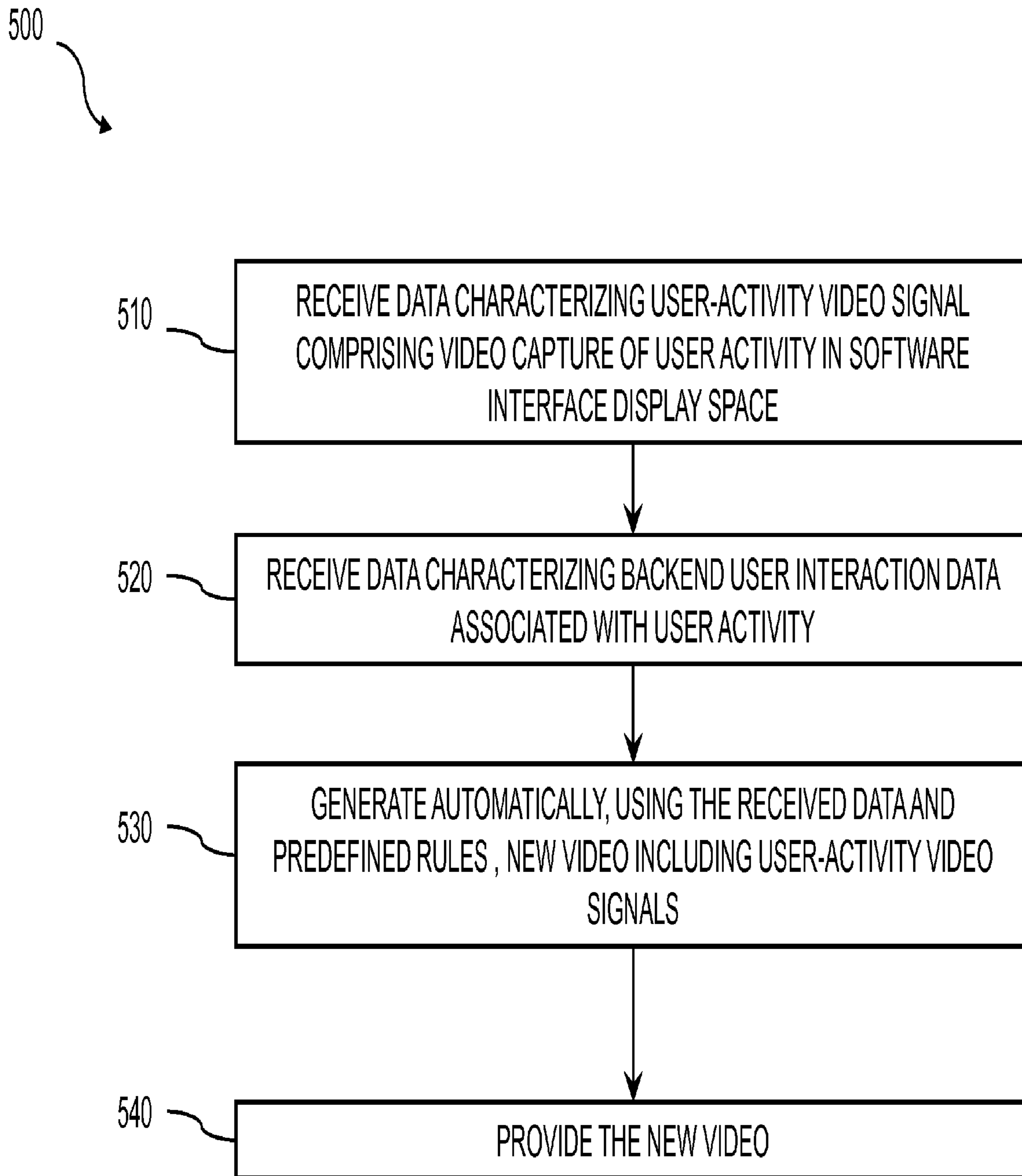

FIG. 5

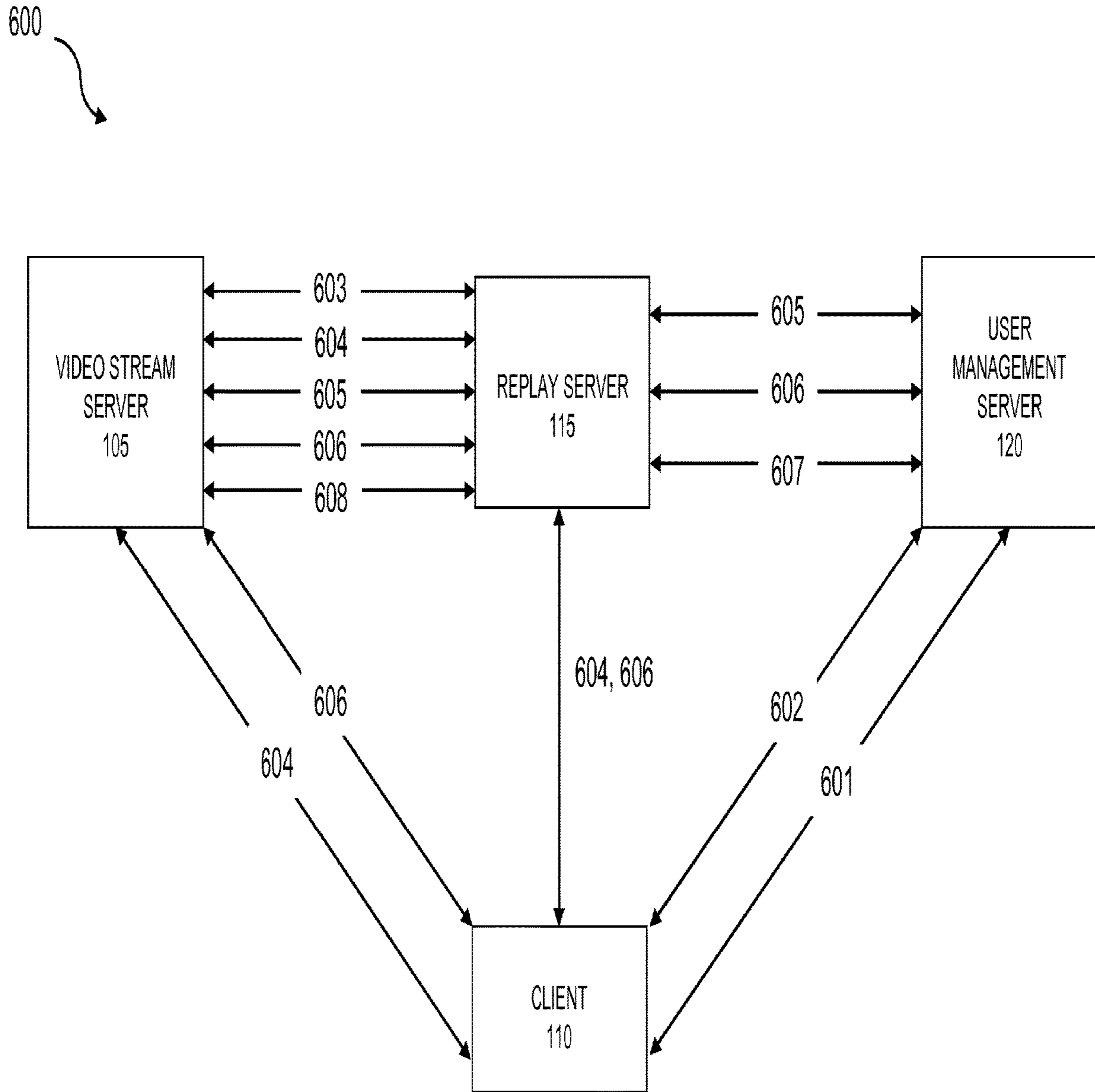

FIG. 6



## ONLINE SOFTWARE VIDEO CAPTURE AND REPLAY SYSTEM

### RELATED APPLICATION

This application is a continuation application of U.S. patent application Ser. No. 15/494,776, filed Apr. 24, 2017, which is a continuation application of U.S. patent application Ser. No. 14/224,889, filed Mar. 25, 2014, which claims priority to U.S. Provisional Patent Application No. 61/930,406, filed Jan. 22, 2014, the contents of each of which are hereby incorporated by reference in their entirety.

### TECHNICAL FIELD

The subject matter described herein relates to capturing, storing, modifying, and retrieving video content related to user activity in a software application.

### BACKGROUND

While it is common for video games to be designed with the experience of the player in game being the only priority, many successful electronic sports (eSports) games are being designed to be played professionally. Video game genres associated with electronic sports can include but are not limited to real-time strategy, fighting, first-person shooter, and multiplayer online battle tournaments. In addition to allowing players to participate a given game, many game developers have added dedicated observing features for the benefit of spectators and competitors. This typically can consist of simply allowing players to watch the game unfold through an online video stream of gameplay.

### SUMMARY

In an aspect, a user-activity video signal can be received. The user-activity video signal can comprise a video capture characterizing a user's interaction with a software application on a client. The software application can have an interface display space on the client and the software application can execute on the client in operation with at least one remote backend computing system. Backend user interaction data corresponding to the user's interaction with the software application as generated by the at least one remote backend computing system can be received. A new video comprising a plurality of divided segments of the user-activity video signal can be generated automatically using the backend user interaction data and a plurality of predefined rules. The new video can be provided.

In another aspect, a system can include a video stream server and a replay server. The video stream server can receive from each of one or more clients a user-activity video signal comprising a video capture characterizing a user's interaction with a software application on the client. The software application can have an interface display space on the client and the software application can be executing on the client in operation with at least one remote backend computing system. The replay server can receive data characterizing backend user interaction data corresponding to the user's interaction with the software application as generated by the at least one remote backend computing system. The replay server can generate automatically, using the backend user interaction data and a plurality of predefined rules, dynamic commands for instructing the video stream server to create a new video comprising a plurality of divided segments of the user-activity video signals.

One or more of the following can be included. For example, events of interest can be detected from the backend user interaction data. The divided segments of the user-activity video signals can correlate in time to the events of interest. The new video can be generated substantially contemporaneously with reception of the user-activity video signal. The interface display space can include a user interface of an online multiplayer video game. The user-activity video signal can be created at the client by one or more of: capturing user interface screen shots at a predetermined rate; capturing open graphics library (OpenGL) layers; and capturing data through a pixel buffer and forming video data from the captured data. Providing can include one or more of storing, streaming, and displaying. A user-activity video signal can be received from each of a plurality of clients. The new video can be a composition of divided segments of video signals from a plurality of clients.

The replay server can detect events of interest from the backend user interaction data. The dynamic commands can be generated substantially contemporaneously with reception by the video stream server of the user-activity video signals. The dynamic commands can specify which divided segments of the user-activity video signals to include in the new video. The interface display space can include a user interface of an online multiplayer video game. The backend user interaction data can include one or more of: user identification, in-game player information, player history, and in-game player characteristics. The video stream server can store each received user-activity video signal and the new video. The video stream server can broadcast to one or more third party destinations the received user-activity video signals as the user-activity video signals are being received by the video stream server. Each of the user-activity video signals can be created at the respective client by one or more of: capturing user interface screen shots at a predetermined rate; capturing open graphics library (OpenGL) layers; and capturing data through a pixel buffer and forming video data from the captured data.

Computer program products are also described that comprise non-transitory computer readable media storing instructions, which when executed by at least one data processors of one or more computing systems, causes at least one data processor to perform operations herein. Similarly, computer systems are also described that may include one or more data processors and a memory coupled to the one or more data processors. The memory may temporarily or permanently store instructions that cause at least one processor to perform one or more of the operations described herein. In addition, methods can be implemented by one or more data processors either within a single computing system or distributed among two or more computing systems.

The subject matter described herein provides many advantages. For example, the current subject matter can enable improved viewing, monitoring, and/or analysis of user-activity on a client. The current subject matter can enable gathering, usage, management, categorization, reuse, and modification of potentially large quantities of user-activity video and associated data. Additionally, the current subject matter can enable cheating prevention, fraud prevention, competitive oversight, security augmentation, increased visibility, advertising, sponsorship opportunities, video editing, video reuse, data collection, data analysis, education, and spectator based entertainment.

The details of one or more variations of the subject matter described herein are set forth in the accompanying drawings and the description below. Other features and advantages of

the subject matter described herein will be apparent from the description and drawings, and from the claims.

#### DESCRIPTION OF DRAWINGS

FIG. 1 is a system diagram illustrating an example implementation of an online software video replay system;

FIG. 2A is a graph of in-game score over time;

FIG. 2B is a line plot illustrating an example sampling of a user-activity video signal at user-activity events of interest to create automatically generated content;

FIG. 3 is a system diagram of another example implementation of an online software video replay system;

FIG. 4 is a process flow diagram of a process for video recording of activity in a software interface display space;

FIG. 5 is a process flow diagram of an example method for automatically generating a new video; and

FIG. 6 is a system block diagram illustrating data flow for capturing, storing, modifying, and retrieving video content for a user enrolling in an online multiplayer video game tournament.

Like reference symbols in the various drawings indicate like elements.

#### DETAILED DESCRIPTION

FIG. 1 is a system diagram illustrating an example implementation of an online software video replay system (and sometimes referred to herein as “OSVRS”) 100. OSVRS 100 can include a video stream server 105 in communication with one or more clients 110 and a replay server 115. The clients 110 and the replay server 115 can be in communication with a user management server 120. The client’s 110 can include a software application 125 with a user interface. In some example implementations, the software application 125 can include an online multiple player video game application in which users compete in tournaments against one another.

In some example implementations, OSVRS 100 can facilitate capture of video of activity in a software interface display space; enable processing, streaming, and storing of the captured video; and support retrieval, usage, and sharing of video content within an online system. OSVRS 100 can also automatically generate new video content from the previously captured video based at least on backend user interaction data related to the user activity, for example, automatically creating a “highlights” video of users’ play in an online multiplayer video game. In some implementations the received user-activity video signal or the new video content can be rebroadcast to one or more third party destinations 130 as the user-activity video signals are being received or as the new video content is created. The rebroadcasting can be for viewing or other processing.

The video stream server 105 can be configured to receive from one or more clients 110 a user-activity video signal or video stream related to activity of the user on the respective client 110. The user-activity video signal can include a video capture of a user interface display space. For example, screen shots of a graphical user interface and any images displayed therein can be captured at an appropriate rate and streamed to the video stream server 105. The user-activity video signal can also include metadata related to the video capture such as time of capture, user identification, software identification, location based data, user input, hardware identification, and the like. The video stream server 105 can store and archive the received user-activity video signals and

serve as a repository of previously received or currently received user-activity video signals.

The user management server 120 can manage and perform functionalities related to software application 125. For example, if software application 125 is an online multiple player video game, the user management server 120 can manage game-specific data, traffic, and other game related activities (e.g., a game hosting server). The user management server 120 can track a user’s access or use of electronic resources for security purposes. For example, if software application 125 is an online consumer banking application, the user management server 120 can manage transaction specific data, traffic, and other related user interactions. The user management server 120 can generate or monitor backend user interaction data that is specific to, corresponding to, and/or relevant to the software application 125 such as actions taken by the user or events occurring in an instance of the software application 125. The backend user interaction data can include contextual information related to activity taken by a user in the software application 125. In the example implementation in which the software application 125 is an online multiple player video game, backend user interaction data can include player identity; player history; transaction history; and in-game characteristics such as score, range of scores, timing of scoring, opponent kills, and the like. The user management server 120 can be a remote backend server. The user management server 120 can send the backend user interaction data to the replay server 115.

The replay server 115 can receive the backend user interaction data from the user management server 120. The replay server 115 can also be in communication with the video stream server 105 and can receive the video signal metadata from the video stream server 105. The replay server 115 can monitor the state of the video stream server 105 with respect to each user-activity video signal. For example, the state of the video stream server 105 with respect to each user-activity video signal can include whether the user-activity is initializing, on-going, finished, real-time rebroadcasting (or live), retroactive viewing, editing, and the like. The replay server 115 can also include a plurality of predefined rules such as a rule set, which can be applied to the backend user interaction data, the state of the video stream server 105, and the video metadata, to automatically generate commands for instructing the video stream server 105 to create new content (e.g., a new video) from the user-activity video signals. The rule set can define what the new content should be comprised of.

In some example implementations, a rules or inference engine can be included and used by the replay server 115 for automatically generating commands for instructing the video stream server 105 to create a new video. A rules engine can operate by executing a cycle of matching, selecting, and executing rules until there are no more rules to execute. Rule engines can be state-based and can implement complex behaviors as a result of chaining individual rules. Rules may not be executed sequentially and it may not always be possible to determine through inspection of a set of rules which rule will be executed first.

In some implementations, the replay server 115 can generate the commands substantially contemporaneously with, or in substantially real-time with, the reception of backend user interaction data and video metadata. In other implementations, the replay server 115 can generate the commands for a user-activity video signal previously stored on the video stream server 105. The generation of commands using, for example, a state-based rules engine, can

5

result in dynamic commands, which change over time as different backend user interaction data and video metadata is received and/or processed by the rules engine. In other words, the generation of commands can be noncausal (e.g., the commands have some dependence on backend user interaction data values from the future). For example, a segment of a user-activity signal may not be determined to be included in the new video until an occurrence of a later detectable event. The dynamic commands can specify which portions or divided segments of the user-activity video signals to include in the new video.

The replay server **115** can transmit the generated commands to the video stream server **105**. The video stream server **105** can, based on the commands, generate the new content or video. The new content can be broadcast, viewed, stored, and the like, by the video stream server **105**.

The new content or new video can comprise divided segments of video signals from multiple clients. For example, the segments can be combined in parallel such that two video signals are displayed concurrently in time (e.g., the new video includes two side-by-side and simultaneous user-activity videos), which can enable user-activity comparison between two or more users. As another example, the segments can be combined in serial such that a segment of a video signal from a first client is displayed, followed by a segment of a video signal from a second client.

In some implementations, the replay server **115** can, using the predefined rules, backend user interaction data, and/or the video metadata, detect user-activity events of interest, which can include detectable changes in video metadata, video stream server **105** state, and/or backend user interaction data. For example, a detectable event of interest in an online game application can include a change of in-game score. FIG. 2A is a graph **200A** of in-game score over time. In the example of FIG. 2A, a change of in-game score occurred at 30 seconds and 1 minute into the video capture. The replay server **115** can detect the change in score. The generated commands can cause the new video to include samples or portions of the user-activity video signal correlating in time to the detected events of interest. FIG. 2B is a line plot **200B** illustrating an example sampling of a user-activity video signal at user-activity events of interest to create automatically generated content. The new video includes the eight seconds prior to and including each change in score (more particularly, at 30 seconds and one minute). The commands can be used to generate a highlights video of gameplay that includes video showing user-activity proximal in time to changes of game score.

In some implementations, the replay server **115** can generate commands that cause the new video to include a specific user-activity video signal based on a priority. The priority can be determined from the backend user interaction data and/or the video metadata. For example, new video or content being rebroadcast substantially in real-time can, for a given moment in time, include the user-activity video signal from a player in an online tournament having the highest score, the most money won, the most damage to opponents, and the like.

The video stream server **105** can, for each received user-activity signal and created new video, provide a uniform resource locator (URL). The URL can be used to provide for distribution and rebroadcasting of the content. Furthermore, the video stream server **105** can index stored videos according to the URL and using a scheme involving user identity. Such indexing allows searching of the stored video content based on user identity.

6

FIG. 3 is a system diagram of another example implementation of an OSVRS system. In the example implementation of FIG. 3, the functionality of the video stream server **105** is performed by the replay server **115** having access to a repository **305** for storing received user-activity video signals and new videos.

FIG. 4 is a process flow diagram **400** of a process for video recording of activity in a software interface display space. Video is captured at **405**. Video capture can be performed by, for example, capturing user-interface display space views through screenshots at a predetermined rate or frames per second. Another example can include capturing open graphics library (OpenGL) layers. Yet another example can include capturing data in a pixel buffer and forming video data from the captured data. Other implementations are possible.

Encoding can be performed at **410**. Encoding can compress the captured video and occurs at the client **110**, using, for example, hardware acceleration. Other encoding implementations are possible.

The encoded video can, at **415**, be placed into temporary files on the client **110**. A watcher function can monitor temporary file size and once a temporary file has reached a predetermined size, the temporary files can be transmitted by the watcher function to the video stream server **105**. The watcher function can optimize the speed and efficiency of data transmission. FIG. 5 is a process flow diagram **500** of an example method for automatically generating a new video. A user-activity video signal can be received at **510** from one or more clients **110**. The user-activity video signal can include a video capture of user activity in a software interface display space on a client **110**.

Backend user interaction data associated with the user activity can be received at **520**. The backend user interaction data can include, for example, contextual information related to activity taken by a user in a software application **125** on the client **110**. In the example implementation in which the software application **125** is an online multiple player video game, backend user interaction data can include player identity; player history; and in-game characteristics such as score, timing of scoring, opponent kills, and the like.

Using the backend user interaction data and predefined rules, a new video can be generated automatically at **530**. The new video can include at least a divided segment of the one or more user-activity video signals.

The new video can be provided at **540**. Providing can include, for example, storing, streaming, broadcasting, processing, and displaying.

FIG. 6 is a system block diagram illustrating data flow for capturing, storing, modifying, and retrieving video content for a user enrolling in an online multiplayer video game tournament. At **601**, a player enters an online or other computer implemented game provided by the user management server **120** (e.g., a game hosting server). The client **110** at **602** notifies the user management server **120** and the replay server **115** that a game has been initiated. The replay server **115** at **603** provides streaming credentials to client **110** and video stream server **105**. The client **110** and video stream server **105** can at **604** initiate the user-activity video signal stream. Additionally, the video stream server **105** can notify the replay server **115** that a video stream session has begun and provide a URL. The replay server **115** at **605** can monitor the state of the video stream and report the state to the user management server **120**. The user management server **120** can provide backend user interaction data related to the video game to the replay server **115** such as the score of each player enrolled in the tournament and their identities.

The replay server 115 can, at 606, begin to generate dynamic commands for generating new content (for example, as described with respect to FIG. 5). Alternatively, the user management server 120 can notify the replay server 115 at 607 when the tournament has completed and the video stream between the client 110 and the video stream server 105 (or, e.g., game tournament) can complete prior to generation of the dynamic commands. The dynamic commands can be transmitted to the video stream server 105 for generation of a new video. The video stream server 105 can generate the new video or content and provide a URL to the replay server 115.

In some implementations, a user, having entered and participated in the online gaming competition, can access both the entire user-activity video signal (for example, to review gameplay), or an automatically generated highlights video of the online gaming competition.

The current subject matter can be used for a number of applications. For example, the current subject matter can be applied towards video game players that are competing in a multiplayer online gaming environment. The current subject matter can be used for cheating and fraud prevention. For example, when backend user interaction data indicates suspicious user activity, a new video can be automatically generated showing the user's suspicious activity and a game or system administrator can review the generated video. Additional uses for the current subject matter can include fraud prevention; competitive oversight; security augmentation; increased visibility; advertising; sponsorship opportunities; video editing and reuse; data collection and analysis; and education and spectator based entertainment.

Various implementations of the subject matter described herein may be realized in digital electronic circuitry, integrated circuitry, specially designed ASICs (application specific integrated circuits), computer hardware, firmware, software, and/or combinations thereof. These various implementations may include implementation in one or more computer programs that are executable and/or interpretable on a programmable system including at least one programmable processor, which may be special or general purpose, coupled to receive data and instructions from, and to transmit data and instructions to, a storage system, at least one input device, and at least one output device.

These computer programs (also known as programs, software, software applications or code) include machine instructions for a programmable processor, and may be implemented in a high-level procedural and/or object-oriented programming language, and/or in assembly/machine language. As used herein, the term "machine-readable medium" refers to any computer program product, apparatus and/or device (e.g., magnetic discs, optical disks, memory, Programmable Logic Devices (PLDs)) used to provide machine instructions and/or data to a programmable processor, including a machine-readable medium that receives machine instructions as a machine-readable signal. The term "machine-readable signal" refers to any signal used to provide machine instructions and/or data to a programmable processor.

To provide for interaction with a user, the subject matter described herein may be implemented on a computer having a display device (e.g., a CRT (cathode ray tube) or LCD (liquid crystal display) monitor) for displaying information to the user and a keyboard and a pointing device (e.g., a mouse or a trackball) by which the user may provide input to the computer. Other kinds of devices may be used to provide for interaction with a user as well; for example, feedback provided to the user may be any form of sensory

feedback (e.g., visual feedback, auditory feedback, or tactile feedback); and input from the user may be received in any form, including acoustic, speech, or tactile input.

The subject matter described herein may be implemented in a computing system that includes a back-end component (e.g., as a data server), or that includes a middleware component (e.g., an application server), or that includes a front-end component (e.g., a client computer having a graphical user interface or a Web browser through which a user may interact with an implementation of the subject matter described herein), or any combination of such back-end, middleware, or front-end components. The components of the system may be interconnected by any form or medium of digital data communication (e.g., a communication network). Examples of communication networks include a local area network ("LAN"), a wide area network ("WAN"), and the Internet.

The computing system may include clients and servers. A client and server are generally remote from each other and typically interact through a communication network. The relationship of client and server arises by virtue of computer programs running on the respective computers and having a client-server relationship to each other.

Although a few variations have been described in detail above, other modifications are possible. For example, the implementations described above can be directed to various combinations and subcombinations of the disclosed features and/or combinations and subcombinations of several further features disclosed above. In addition, the logic flows depicted in the accompanying figures and described herein do not require the particular order shown, or sequential order, to achieve desirable results. Other embodiments may be within the scope of the following claims.

What is claimed is:

1. A method for implementation by one or more data processors forming part of at least one computing system, the method comprising:

receiving, by at least one data processor, a first user-activity video signal from a first client and a second user-activity video signal from a second client, the first user-activity video signal comprising a first video capture characterizing a first user's interaction with a first software application on the first client, the second user-activity video signal comprising a second video capture characterizing a second user's interaction with a second software application on the second client;

receiving, by at least one data processor, backend user interaction data corresponding to the first user's interaction with the first software application and the second user's interaction with the second software application;

detecting, by at least one data processor and using the backend user interaction data, suspicious user-activity events in at least one of the first user's interaction or the second user's interaction;

generating automatically, by at least one data processor and using the backend user interaction data, the detected suspicious user-activity events, and a plurality of predefined rules, a new combined video comprising a plurality of divided segments of the first user-activity video signal and the second user-activity video signal, the new combined video simultaneously displaying segments of the first user-activity video signal adjacent to segments of the second user-activity video signal in the new combined video, wherein one or more segments of the plurality of divided segments comprise the detected suspicious user-activity events; and providing the new combined video.

9

2. The method of claim 1, further comprising:  
detecting events of interest from the backend user interaction data, wherein at least one of the first user-activity video signal or the second user-activity video signal correlates in time to the events of interest.
3. The method of claim 1, wherein the new combined video is generated substantially contemporaneously with reception of at least one of the first user-activity video signal or the second user-activity video signal.
4. The method of claim 1, wherein the first software application includes an interface display space on the first client, and wherein the interface display space comprises a user interface of an online multiplayer video game.
5. The method of claim 1, wherein each of the first and second user-activity video signals is created at the respective client by one or more of:  
capturing user interface screen shots at a predetermined rate; capturing open graphics library (OpenGL) layers; and  
capturing data through a pixel buffer and forming video data from the captured data.
6. The method of claim 1, wherein the providing includes one or more of storing, streaming, and displaying.
7. A non-transitory computer program product storing instructions, which when executed by at least one data processor of at least one computing system, implement a method comprising:  
receiving, by at least one data processor, a first user-activity video signal from a first client and a second user-activity video signal from a second client, the first user-activity video signal comprising a first video capture characterizing a first user's interaction with a first software application on the first client, the second user-activity video signal comprising a second video capture characterizing a second user's interaction with a second software application on the second client;  
receiving, by at least one data processor, backend user interaction data corresponding to the first user's interaction with the first software application and the second user's interaction with the second software application;  
detecting, by at least one data processor and using the backend user interaction data, suspicious user-activity events in at least one of the first user's interaction or the second user's interaction;  
generating automatically, by at least one data processor and using the backend user interaction data, the detected suspicious user-activity events, and a plurality of predefined rules, a new combined video comprising a plurality of divided segments of the first user-activity video signal and the second user-activity video signal, the new combined video simultaneously displaying segments of the first user-activity video signal adjacent to segments of the second user-activity video signal in the new combined video, wherein one or more segments of the plurality of divided segments comprise the detected suspicious user-activity events; and  
providing the new combined video.
8. The non-transitory computer program product of claim 7, the method further comprising:  
detecting events of interest from the backend user interaction data, wherein at least one of the first user-activity video signal or the second user-activity video signal correlates in time to the events of interest.
9. The non-transitory computer program product of claim 7, wherein the new combined video is generated substan-

10

- tially contemporaneously with reception of at least one of the first user-activity video signal or the second user-activity video signal.
10. The non-transitory computer program product of claim 7, wherein the first software application includes an interface display space on the first client, and wherein the interface display space comprises a user interface of an online multiplayer video game.
11. A system comprising:  
a video stream server comprising at least one data processor and memory storing instructions which, when executed by the at least one data processor, causes the at least one data processor to perform operations comprising:  
receiving a first user-activity video signal from a first client and a second user-activity video signal from a second client, the first user-activity video signal comprising a first video capture characterizing a first user's interaction with a first software application on the first client, the second user-activity video signal comprising a second video capture characterizing a second user's interaction with a second software application on the second client; and  
a replay server comprising at least one data processor and memory storing instructions which, when executed by the at least one data processor, causes the at least one data processor to perform operations comprising:  
receiving backend user interaction data corresponding to the first user's interaction with the first software application and the second user's interaction with the second software application;  
detecting, using the backend user interaction data, suspicious user-activity events in at least one of the first user's interaction or the second user's interaction; and  
generating automatically, using the backend user interaction data, the detected suspicious user-activity events, and a plurality of predefined rules, dynamic commands for instructing the video stream server to create a new combined video comprising a plurality of divided segments of the first user-activity video signal and the second user-activity video signal, the new combined video simultaneously displaying segments of the first user-activity video signal adjacent to segments of the second user-activity video signal in the new combined video, wherein one or more segments of the plurality of divided segments comprise the detected suspicious user-activity events.
12. The system of claim 11, wherein the replay server is further configured to detect events of interest from the backend user interaction data; and wherein at least one of the first user-activity video signal or the second user-activity video signal correlates in time to the events of interest.
13. The system of claim 11, wherein the dynamic commands are generated substantially contemporaneously with reception by the video stream server of at least one of the first user-activity video signal or the second user-activity video signal.
14. The system of claim 11, wherein the dynamic commands specify which divided segments of each of the first user-activity video signal and the second user-activity video signal to include in the new combined video.
15. The system of claim 11, wherein the first software application includes an interface display space on the first client, and wherein the interface display space comprises a user interface of an online multiplayer video game.

**16.** The system of claim **12**, wherein backend user interaction data comprises one or more of: user identification, in-game player information, player history, and in-game player characteristics.

**17.** The system of claim **11**, wherein the video stream server is further configured to store the received first user-activity video signal, the received second user-activity video signal, and the new combined video. 5

**18.** The system of claim **11**, wherein the video stream server can broadcast to one or more third party destinations the received first user-activity video signal and the received second user-activity video signal as the first and second user-activity video signals are being received by the video stream server. 10

**19.** The system of claim **11**, wherein each of the first and second user-activity video signals is created at the respective client by one or more of: capturing user interface screen shots at a predetermined rate; capturing open graphics library (OpenGL) layers; and capturing data through a pixel buffer and forming video data from the captured data. 15 20

\* \* \* \* \*